

GEEIGNET ZUR GEWINDEREGENERATION ODER UM SEHR WIDERSTANDSFÄHIGES GEWINDESCHNEIDEN IN WEICHE MATERIALIEN ZU ERHALTEN.

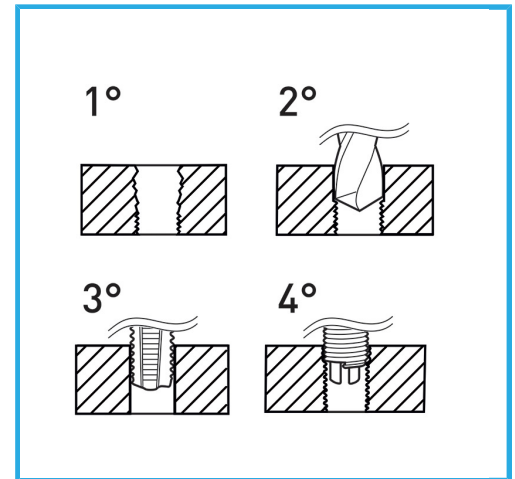

Gewinde	1/2" x 12
Bohrer	Ø 13.0 mm
Gewindebohrer STI	E011/BSW1/2M
Montagewerkzeug	E011/U15 g
Brechwerkzeug	E011/A15 g
Gewindeeinsätze	E010/BSW1/2E15
Anzahl der Einsätze	10
Bruttogewicht	0,70 kg
EAN-Code	8012667368005



Aufhängbar

HSS



INOX