

SUITABLE FOR THREAD REGENERATION OR TO OBTAIN VERY RESISTANT TAPPING IN SOFT MATERIALS.

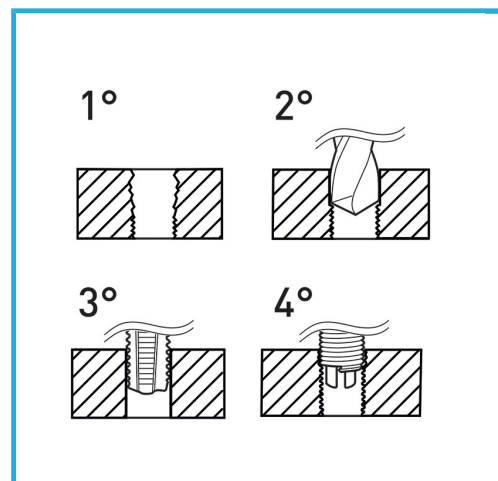

Thread	1/2" x 12
Boring bit	Ø 13.0 mm
STI Taps	E011/BSW1/2M
Inserting tool	E011/U15
Tang break tool	E011/A15
Wire-thread inserts	E010/BSW1/2E15
Inserts quantity	10
Gross weight	0,70 kg
EAN Code	8012667368005



Hangable

HSS



INOX