

SPECIFICO PER RIPARAZIONI O RINFORZI SEDI CANDELE.

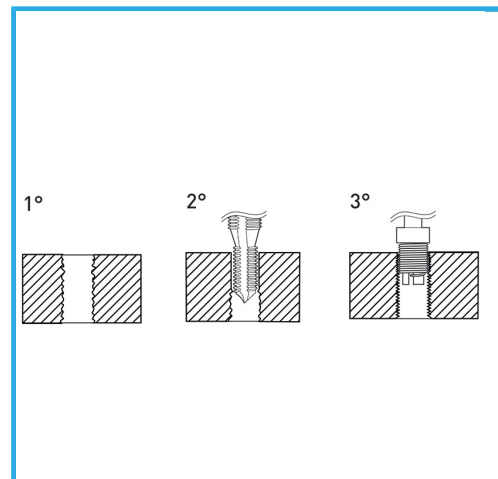

€46,30

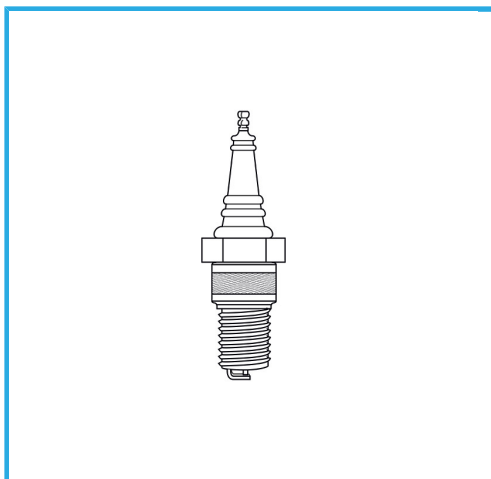

Misura	M 10 x 1.25
Utensile montaggio	E011/U13
Maschi STI	E011/M100X125M
Inserti filettati	10
Codice EAN	8012667366186
Peso lordo	-



Append.

HSS



INOX

-