

SUITABLE FOR THREAD REGENERATION OR TO OBTAIN VERY RESISTANT TAPPING IN SOFT MATERIALS.

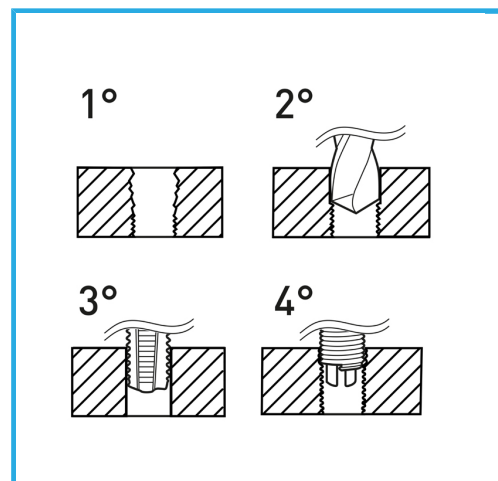

Thread	3/4" x 16
Drills	-
STI Taps	E011/UNF3/4M
Inserting tool	E011/U21
Tang break tool	-
Wire-thread inserts	E010/UNF3/4E15
Inserts quantity	5
Gross weight	0,78 kg
EAN Code	8012667366285



Hangable

HSS



INOX