

SUITABLE FOR THREAD REGENERATION OR TO OBTAIN VERY RESISTANT TAPPING IN SOFT MATERIALS.

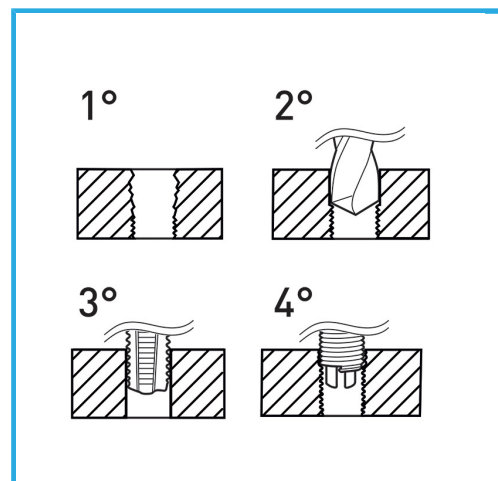

Thread	1/8" x 40
Boring bit	Ø 3.4 mm
STI Taps	E011/BSW1/8M
Inserting tool	E011/U04
Tang break tool	E011/A4
Wire-thread inserts	E010/BSW1/8E15
Inserts quantity	20
Gross weight	0,35 kg
EAN Code	8012667369033



Hangable

HSS

INOX