

INDICADO PARA LA REGENERACIÓN DE ROSCAS O PARA OBTENER ROSCADOS MUY RESISTENTES EN MATERIALES BLANDOS.

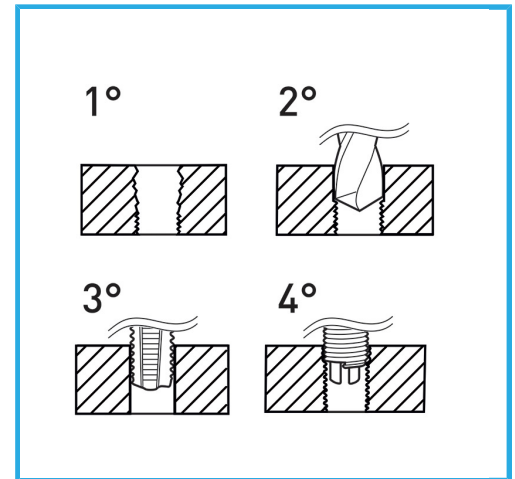

€35,90



Rosca	1/8" x 40
Broca	Ø 3.4 mm
Machos STI	E011/BSW1/8M
Utensilio para insertar	E011/U04
Herr. rompe arrastre	E011/A4
Insertos roscados	E010/BSW1/8E15
Cantidad de insertos	20
Peso bruto	0,35 kg
Codigo de barras	8012667369033



Colgante

HSS



INOX