

ADATTI PER LA RIGENERAZIONE DELLE FILETTATURE O PER OTTENERE DELLE MASCHIATURE MOLTO RESISTENTI IN MATERIALI TENERI.

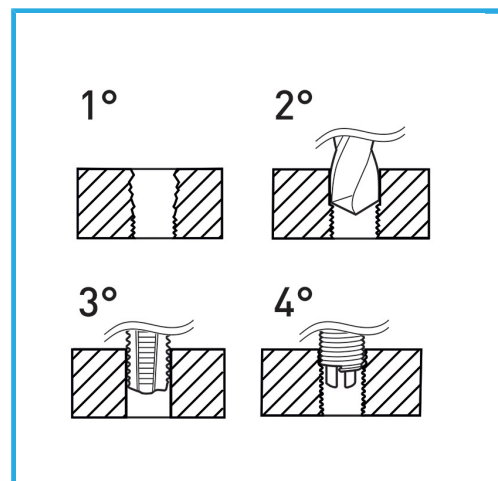

€78,30



Dimensioni	M 20 x 2.5
Punta	-
Maschi STI	E011/M200X250M
Utensile montaggio	E011/U21
Attrezzo rottura	-
Quantità inserti	5
Peso lordo	0,88 kg
Codice EAN	8012667366278



Append.

HSS



INOX