

GEEIGNET ZUR GEWINDEREGENERATION ODER UM SEHR WIDERSTANDSFÄHIGES GEWINDESCHNEIDEN IN WEICHE MATERIALIEN ZU ERHALTEN.

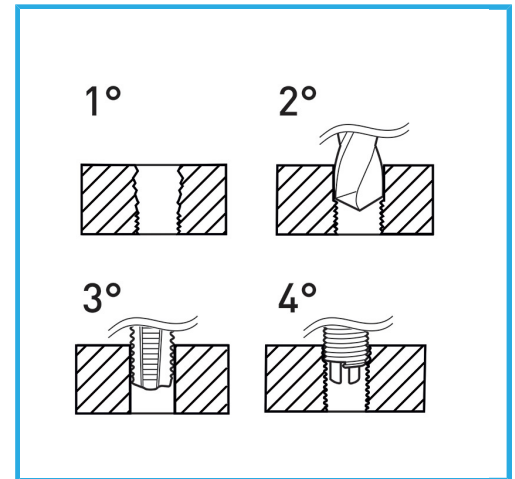

Abmessungen	M 20 x 1.5
Bohrer	-
Gewindebohrer STI	E011/M200X150M
Montagewerkzeug	E011/U21 g
Brechwerkzeug	- g
Anzahl der Einsätze	5
Bruttogewicht	0,80 kg
Verpackungsmaße	170x130x40 h mm
EAN-Code	8012667366223



Aufhängbar

HSS



-