

SPEZIELL FÜR REPARATUREN ODER VERSTÄRKUNG VON
ZÜNDKERZENSITZEN.

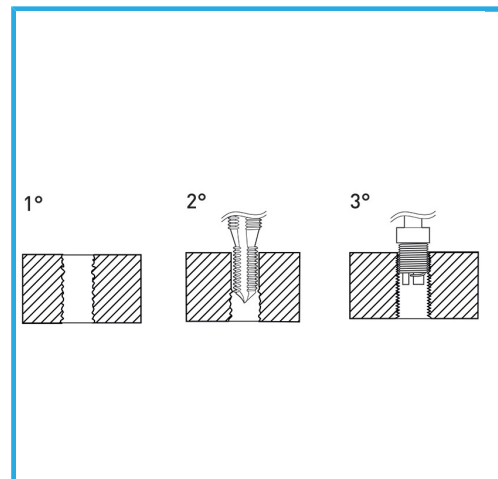
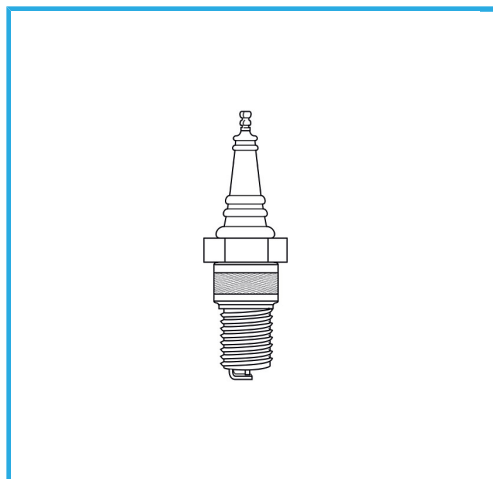

Maß

M 6 x 1.0

Montagewerkzeug

E011/U09 g

Gewindebohrer STI

E011/M060X100M

Gewindeeinsätze

10

EAN-Code

8012667366483

Bruttogewicht

-



Aufhängbar

HSS

-



INOX

-