

SUITABLE FOR THREAD REGENERATION OR TO OBTAIN VERY RESISTANT TAPPING IN SOFT MATERIALS.

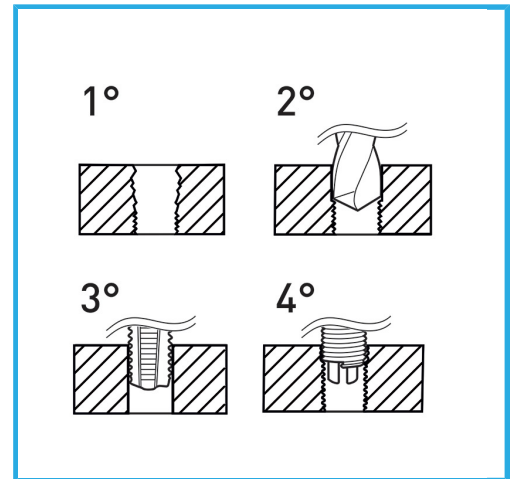

<b>Dimensions</b>	M 10 x 1.0
<b>Boring bit</b>	Ø 10.3 mm
<b>STI Taps</b>	E011/M100X100M
<b>Inserting tool</b>	E011/U13
<b>Tang break tool</b>	E011/A13
<b>Inserts quantity</b>	15
<b>Gross weight</b>	0,53 kg
<b>EAN Code</b>	8012667366568



Hangable

HSS



INOX