

SUITABLE FOR THREAD REGENERATION OR TO OBTAIN VERY RESISTANT TAPPING IN SOFT MATERIALS.

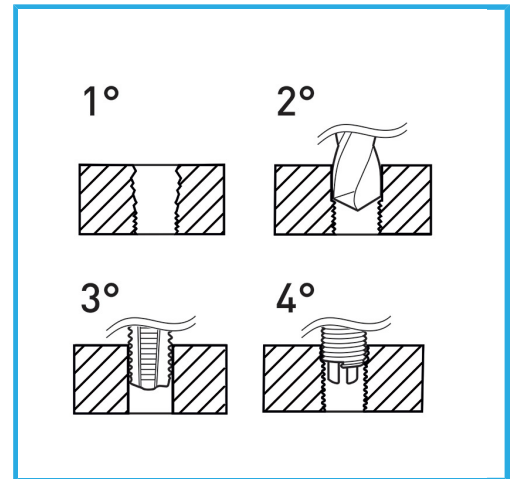

Dimensions	M 9 x 1.0
Boring bit	Ø 9.3 mm
STI Taps	E011/M090X100M
Inserting tool	E011/U12
Tang break tool	E011/A12
Inserts quantity	10
Gross weight	0,54 kg
EAN Code	8012667365189



Hangable

HSS



INOX