

INDICADO PARA LA REGENERACIÓN DE ROSCAS O PARA OBTENER ROSCADOS MUY RESISTENTES EN MATERIALES BLANDOS.

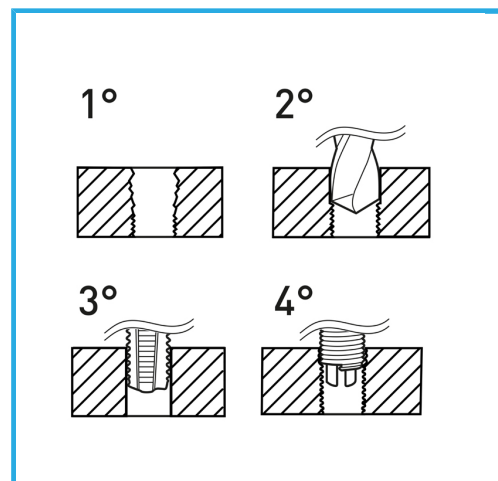

€50,00



Rosca	1/2" x 20
Brocas	Ø 13.0 mm
Machos STI	E011/UNF1/2M
Utensilio para insertar	E011/U15
Herr. rompe arrastre	E011/A15
Insertos roscados	E010/UNF1/2E15
Cantidad de insertos	10
Peso bruto	0,67 kg
Codigo de barras	8012667367978



Colgante

HSS



INOX