

INDICADO PARA LA REGENERACIÓN DE ROSCAS O PARA OBTENER ROSCADOS MUY RESISTENTES EN MATERIALES BLANDOS.

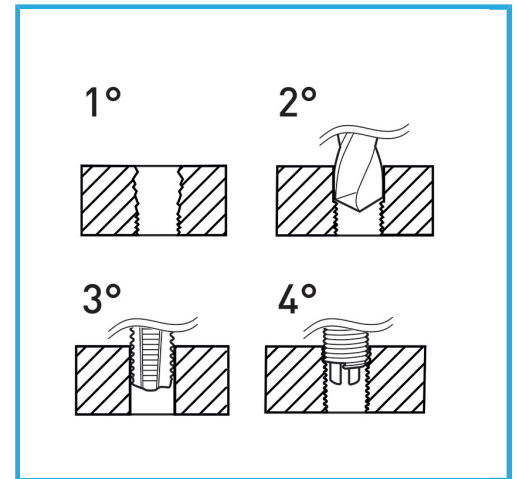

€35,90



Rosca	3/16" x 32
Broca	Ø 5.0 mm
Machos STI	E011/BSF3/16M
Utensilio para insertar	E011/U07
Herr. rompe arrastre	E011/A06
Insertos roscados	E010/BSF3/16E15
Cantidad de insertos	20
Peso bruto	0,37 kg
Codigo de barras	8012667367190



Colgante

HSS



INOX