

ADATTI PER LA RIGENERAZIONE DELLE FILETTATURE O PER OTTENERE DELLE MASCHIATURE MOLTO RESISTENTI IN MATERIALI TENERI.

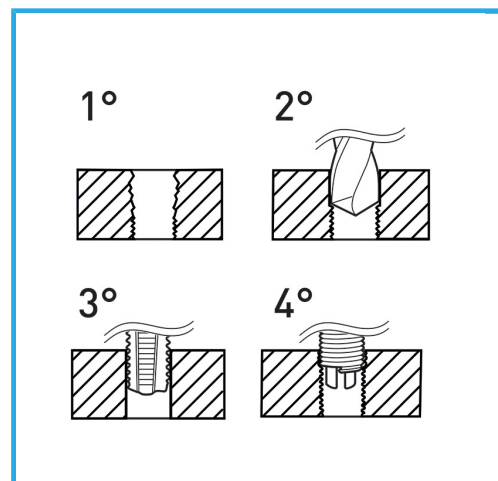

€35,90



Filetto	3/16" x 32
Punta	Ø 5.0 mm
Maschi STI	E011/BSF3/16M
Utensile montaggio	E011/U07
Attrezzo rottura	E011/A06
Inserti filettati	E010/BSF3/16E15
Quantità inserti	20
Peso lordo	0,37 kg
Codice EAN	8012667367190



Append.

HSS

INOX