

SUITABLE FOR THREAD REGENERATION OR TO OBTAIN VERY RESISTANT TAPPING IN SOFT MATERIALS.

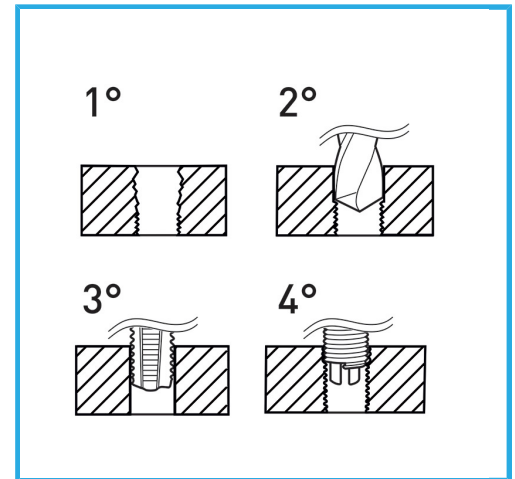

Sizes	M6 - M14 mm
STI Taps	M6 x 1.0 - M8 x 1.25 - M10 x 1.5 - M12 x 1.75 - M14 x 1.25
Drills	6.3 mm - 8.3 mm - 10.4 mm - 12.4 mm
Wire-thread inserts	M6=25 M8=25 M10=25 M12=10 M14=10
Inserting tool	5 Pcs
Tang break tool	4 Pcs
Gross weight	2,66 kg
EAN Code	8012667367329



Carrying case



HSS

-



INOX

-



113 Pcs