

INDICADO PARA LA REGENERACIÓN DE ROSCAS O PARA OBTENER ROSCADOS MUY RESISTENTES EN MATERIALES BLANDOS.

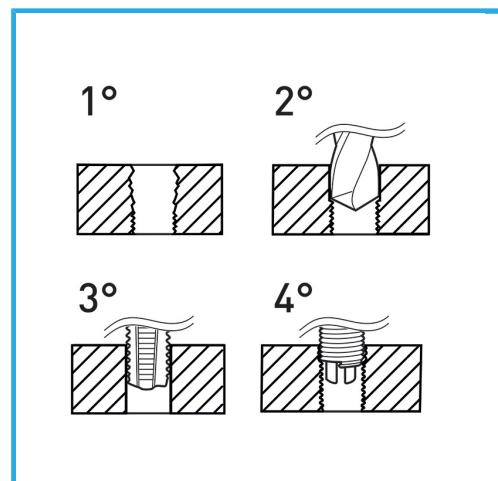

€167,00



Medidas	M6 - M14 mm
Machos STI	M6 x 1.0 - M8 x 1.25 - M10 x 1.5 - M12 x 1.75 - M14 x 1.25
Brocas	6.3 mm - 8.3 mm - 10.4 mm - 12.4 mm
Insertos roscados	M6=25 M8=25 M10=20 M12=15 M14=25
Utensilio para insertar	5 Pz
Herr. rompe arrastre	5 Pz
Peso bruto	2,95 kg
Codigo de barras	8012667364618



Estuche de transporte



HSS

-



INOX

-



125 Pcs