

SUITABLE FOR THREAD REGENERATION OR TO OBTAIN VERY RESISTANT TAPPING IN SOFT MATERIALS.

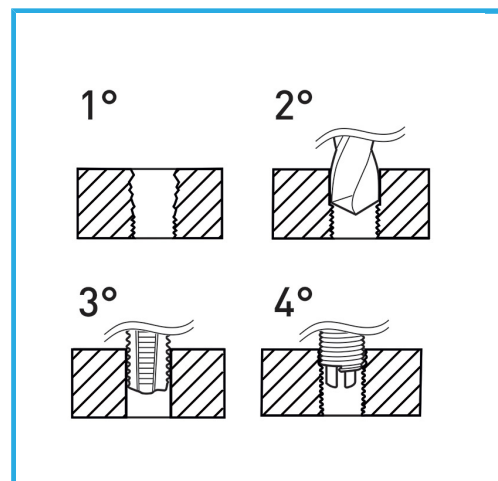

Dimensions	M 8 x 1.0
Boring bit	Ø 8.3 mm
STI Taps	E011/M080X100M
Inserting tool	E011/U11
Tang break tool	E011/A11
Inserts quantity	20
Gross weight	0,47 kg
EAN Code	8012667367138



Hangable

HSS



INOX