

SUITABLE FOR THREAD REGENERATION OR TO OBTAIN VERY RESISTANT TAPPING IN SOFT MATERIALS.

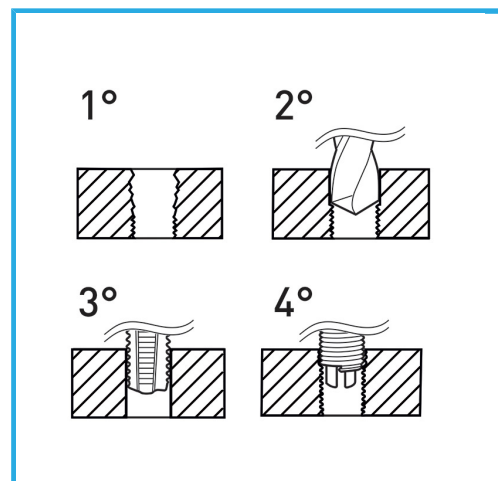

Dimensions	M 22 x 2.5
Boring bit	-
STI Taps	E011/M220X250M
Inserting tool	E011/U22
Tang break tool	-
Inserts quantity	5
Gross weight	1,00 kg
EAN Code	8012667364625



Hangable

HSS



INOX