

SUITABLE FOR THREAD REGENERATION OR TO OBTAIN VERY RESISTANT TAPPING IN SOFT MATERIALS.

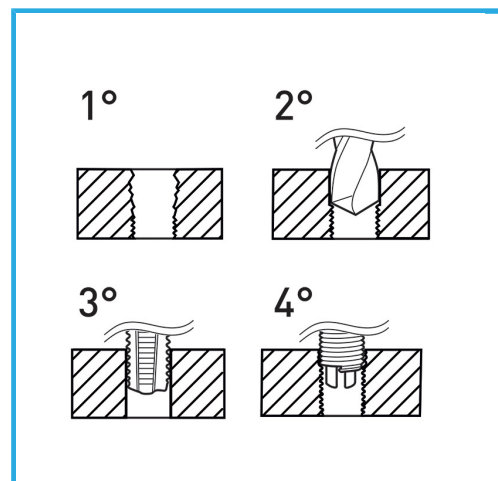

<b>Thread</b>	5/8" x 11
<b>Boring bit</b>	-
<b>STI Taps</b>	E011/BSW5/8M
<b>Inserting tool</b>	E011/U18
<b>Tang break tool</b>	-
<b>Wire-thread inserts</b>	E010/BSW5/8E15
<b>Inserts quantity</b>	10
<b>Gross weight</b>	0,71 kg
<b>EAN Code</b>	8012667366117



Hangable

HSS

INOX