

ADATTI PER LA RIGENERAZIONE DELLE FILETTATURE O PER OTTENERE DELLE MASCHIATURE MOLTO RESISTENTI IN MATERIALI TENERI.

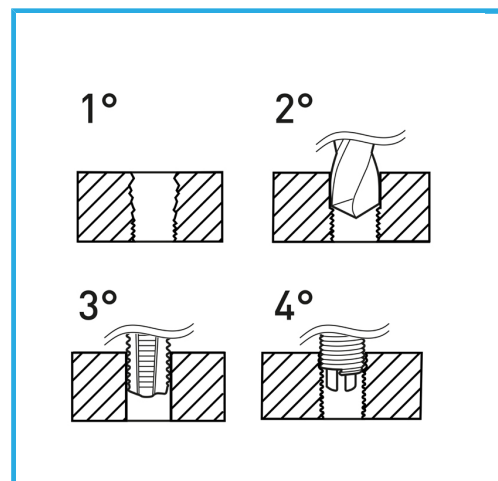

€50,00



Filetto	1/2" x 13
Punte	Ø 13.0 mm
Maschi STI	E011/UNC1/2M
Utensile montaggio	E011/U15
Attrezzo rottura	E011/A15
Inserti filettati	E010/UNC1/2E15
Quantità inserti	10
Peso lordo	0,68 kg
Codice EAN	8012667362966



Append.

HSS

INOX