

SUITABLE FOR THREAD REGENERATION OR TO OBTAIN VERY RESISTANT TAPPING IN SOFT MATERIALS.

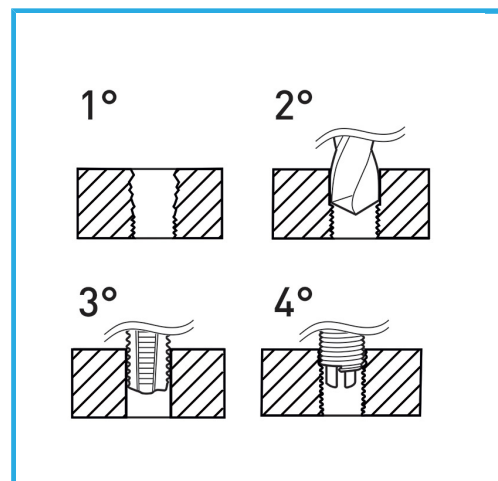

<b>Dimensions</b>	M 14 x 1.5
<b>Boring bit</b>	-
<b>STI Taps</b>	E011/M140X150M
<b>Inserting tool</b>	E011/U17
<b>Tang break tool</b>	-
<b>Inserts quantity</b>	10
<b>Gross weight</b>	0,59 kg
<b>EAN Code</b>	8012667364946



Hangable

HSS



INOX