

INDICADO PARA LA REGENERACIÓN DE ROSCAS O PARA OBTENER ROSCADOS MUY RESISTENTES EN MATERIALES BLANDOS.

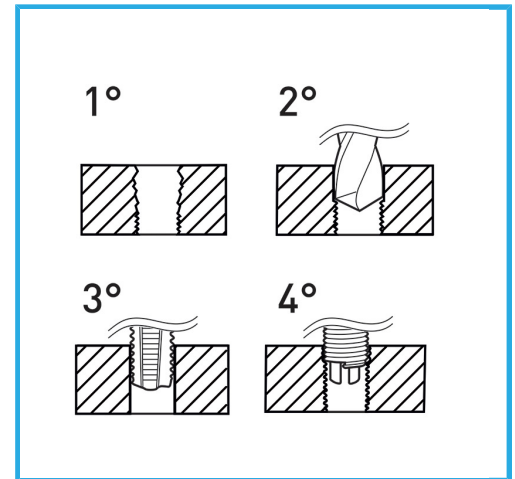

€84,80



Rosca	3/4" x 10
Broca	-
Machos STI	E011/BSW3/4M
Utensilio para insertar	E011/U20
Herr. rompe arrastre	-
Insertos roscados	E010/BSW3/4E15
Cantidad de insertos	5
Peso bruto	0,81 kg
Codigo de barras	8012667366315



Colgante

HSS



INOX