

ADATTI PER LA RIGENERAZIONE DELLE FILETTATURE O PER OTTENERE DELLE MASCHIATURE MOLTO RESISTENTI IN MATERIALI TENERI.

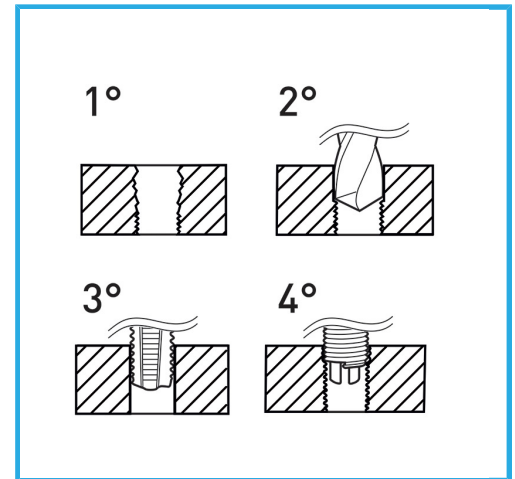

€84,80



Filetto	3/4" x 10
Punta	-
Maschi STI	E011/BSW3/4M
Utensile montaggio	E011/U20
Attrezzo rottura	-
Inserti filettati	E010/BSW3/4E15
Quantità inserti	5
Peso lordo	0,81 kg
Codice EAN	8012667366315



Append.

HSS



INOX