

SONDERAUSFÜHRUNG ZUR HERSTELLUNG DES
GEWINDEEINSATZ-GEHÄUSESITZES.

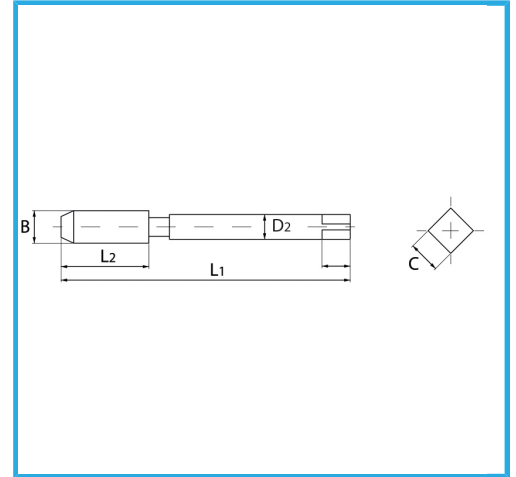

Maß	3/4" x 10
B	22.4 mm
L1	118.0 mm
L2	38.0 mm
D2	16.0 mm
C	12.50 mm
Bruttogewicht	0,21 kg
EAN-Code	8012667366544



Aufhängbar

HSS-G