

SONDERAUSFÜHRUNG ZUR HERSTELLUNG DES  
GEWINDEEINSATZ-GEHÄUSESITZES.

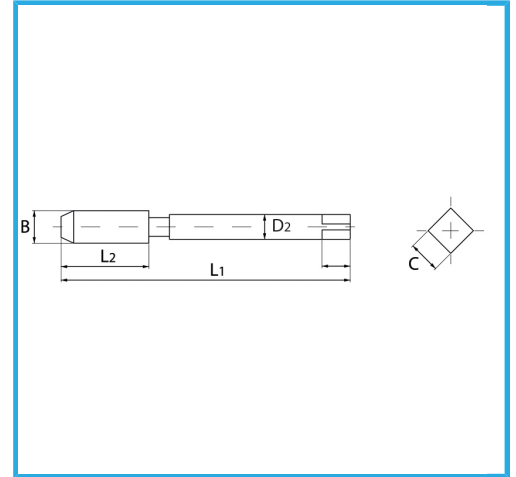

Maß	M 7 x 1.0
B	8.3 mm
L1	72.0 mm
L2	22.0 mm
D2	9.0 mm
C	7.10 mm
Bruttogewicht	0,03 kg
EAN-Code	8012667364960



Box

HSS-G