

SONDERAUSFÜHRUNG ZUR HERSTELLUNG DES  
GEWINDEEINSATZ-GEHÄUSESITZES.

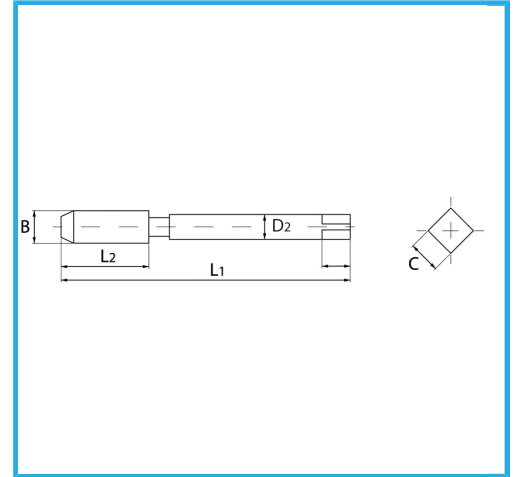

Maß	M 9 x 1.25
B	10.6 mm
L1	85.0 mm
L2	25.0 mm
D2	8.0 mm
C	6.30 mm
Bruttogewicht	0,03 kg
EAN-Code	8012667367985



Box

HSS-G