

ART. P034/090

M14 DIAMOND DRILL BITS AND CORE DRILLS WITH CONTINUOUS EDGE

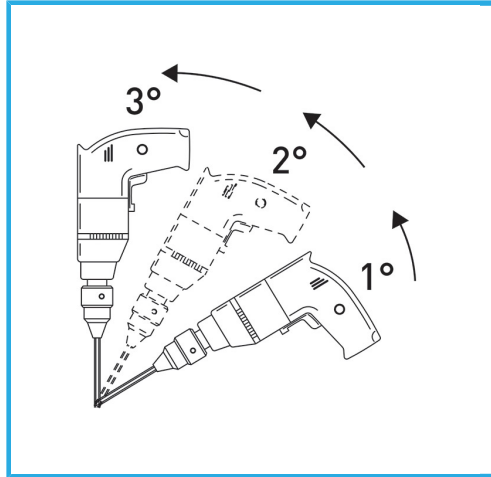

THE THIN-WALL DIAMOND CORE GUARANTEES BURR-FREE CUTS. THIS FEATURE FACILITATES DRILLING WORK ON HARD LAID TILES, WHERE IT IS...



Size	Ø 90 mm
Total length	60 mm
Diamond height	15 mm
Grit	30/50
Gross weight	0,52 kg
EAN Code	8012667355593



Hangable



M14