

# ART. P034/025

M14 DIAMOND DRILL BITS AND CORE DRILLS WITH CONTINUOUS EDGE

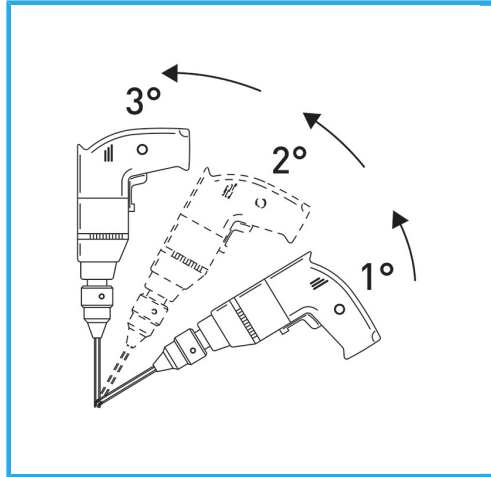

THE THIN-WALL DIAMOND CORE GUARANTEES BURR-FREE CUTS. THIS FEATURE FACILITATES DRILLING WORK ON HARD LAID TILES, WHERE IT IS...



Size	Ø 25 mm
Total length	60 mm
Diamond height	10 mm
Grit	30/50
Gross weight	0,08 kg
EAN Code	8012667355456



Hangable



M14