

# ART. P034/014

M14 DIAMOND DRILL BITS AND CORE DRILLS WITH CONTINUOUS EDGE

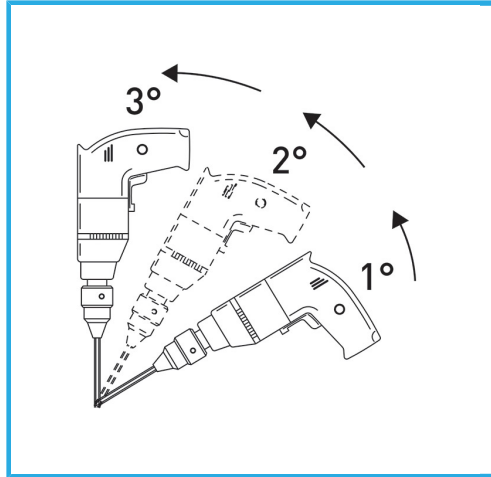

THE THIN-WALL DIAMOND CORE GUARANTEES BURR-FREE CUTS. THIS FEATURE FACILITATES DRILLING WORK ON HARD LAID TILES, WHERE IT IS...



Size	Ø 14 mm
Total length	62 mm
Diamond height	10 mm
Grit	30/50
Gross weight	0,07 kg
EAN Code	8012667355401



Hangable



M14