

EL NÚCLEO DE DIAMANTE DE PARED DELGADA GARANTIZA CORTES SIN REBABAS. ESTA CARACTERÍSTICA FACILITA EL TRABAJO DE...

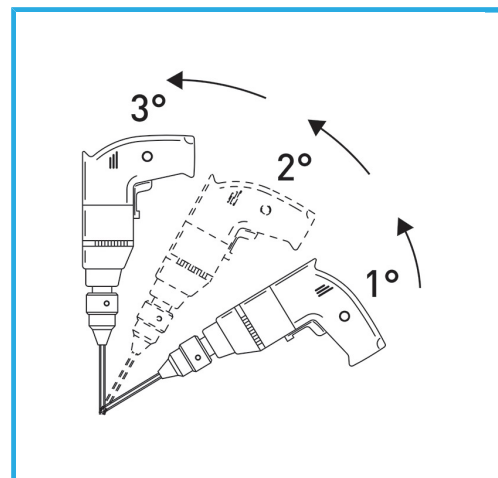

€9,70

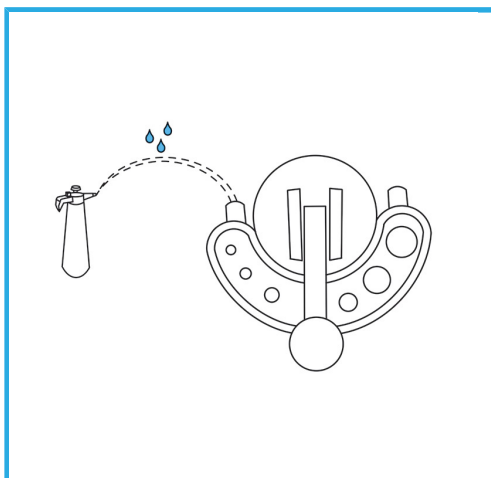

Medida	Ø 12 mm
Eje	Ø 6 mm
Longitud total	65 mm
Altura del diamante	5 mm
Grano	60/80
Peso bruto	0,02 kg
Codigo de barras	8012667355999



Colgante