

OPTIMALER BETRIEB AN SENKRECHTEN WÄNDEN, DEN KERN NICHT ENTFERNEN, DER ALS MESSKAPPE FÜR DAS KÜHLMITTEL DIENT....

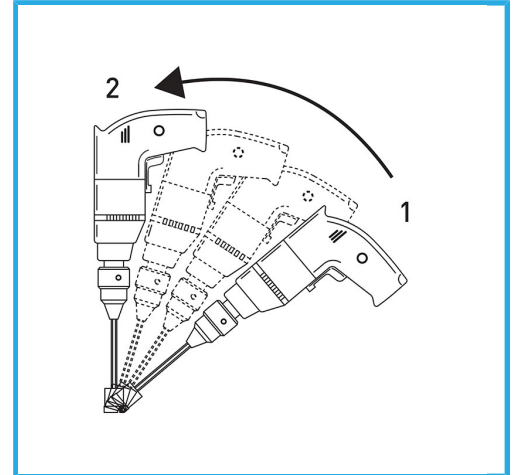

Maß	Ø 10 mm
Sechskantkupplung	9.5 mm g
Gesamtlänge	80 mm
Diamanthöhe	10 mm
Stift	40
Verpackungsmaße	115 x 32 x 32 h mm
Bruttogewicht	0,03 kg
EAN-Code	8012667355845

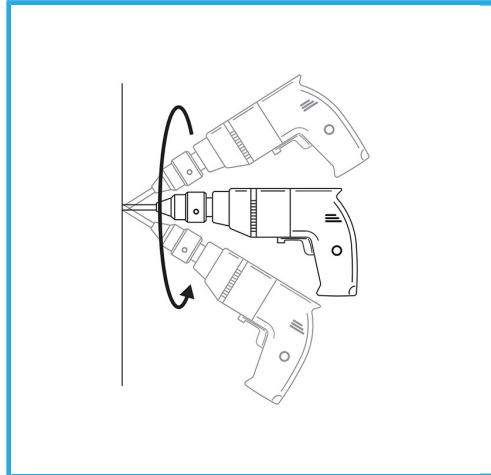

Aufhängbar