

FUNCIONAMIENTO ÓPTIMO EN PAREDES VERTICALES, NO RETIRE EL NÚCLEO, QUE ACTÚA COMO TAPÓN DE MEDICIÓN DEL...

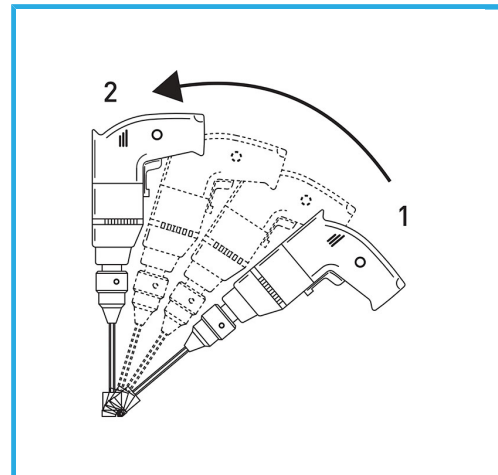

€55,00

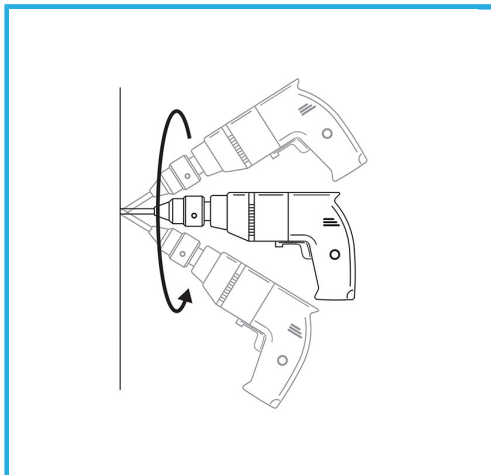

Medida	Ø 22 mm
Conexión hexagonal	12.5 mm
Longitud total	80 mm
Altura del diamante	10 mm
Grano	40
Peso bruto	0,06 kg
Codigo de barras	8012667355906



Colgante