

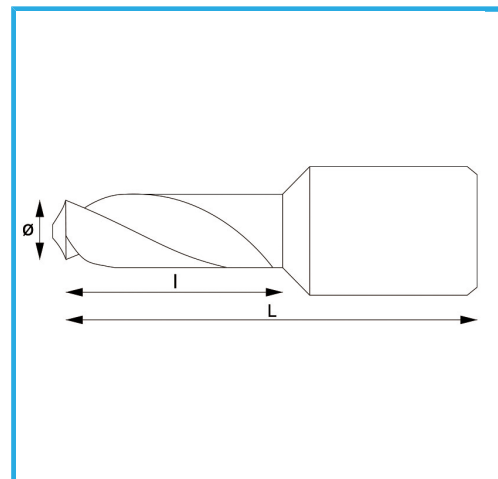

€28,00



Ø	7 mm
l	30 mm
L	62.50 mm
Peso lordo	0,07 kg
Codice EAN	8012667355647



Append.

HSS
CO 5%



135°