

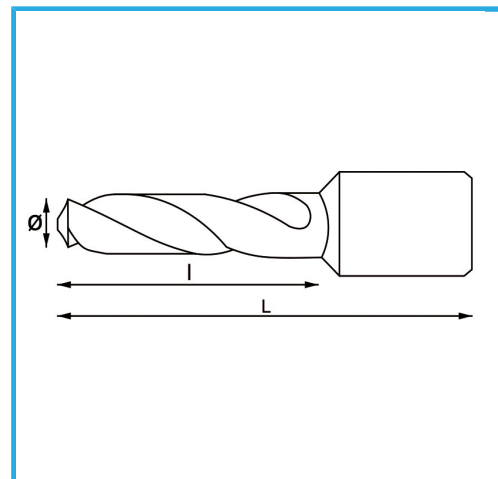

€36,40



Ø	8 mm
l	55 mm
L	86.50 mm
Peso bruto	0,08 kg
Codigo de barras	8012667355715



Colgante

HSS
CO 5%



135°