

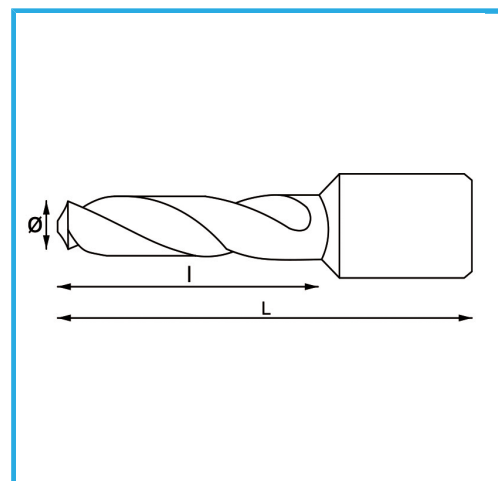

€36,40



Ø	8 mm
l	55 mm
L	86.50 mm
Peso lordo	0,08 kg
Codice EAN	8012667355715



Append.

HSS
CO 5%



135°