

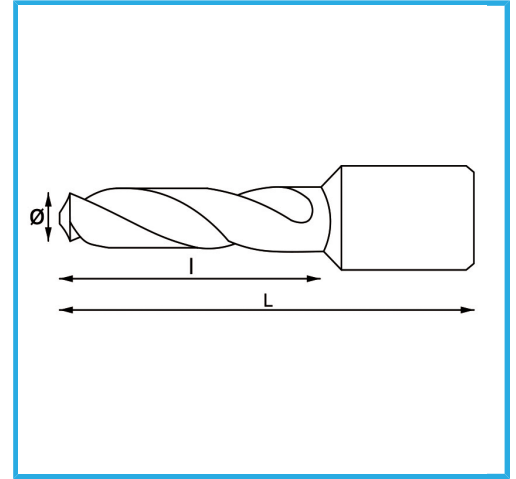

€36,40



Ø	6 mm
l	55 mm
L	86.50 mm
Peso bruto	0,07 kg
Codigo de barras	8012667355692



Colgante

HSS  
CO 5%



135°