

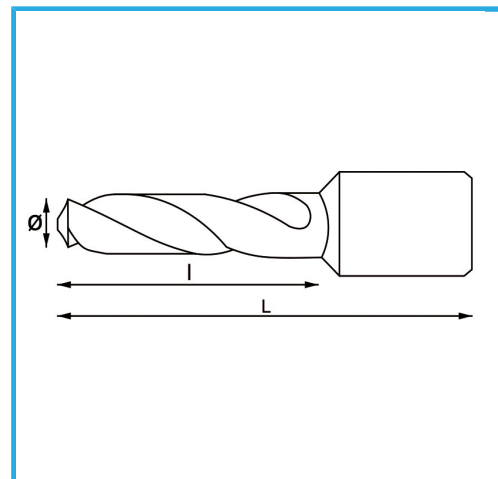

€36,40



| | |
|------------|---------------|
| Ø | 6 mm |
| l | 55 mm |
| L | 86.50 mm |
| Peso lordo | 0,07 kg |
| Codice EAN | 8012667355692 |



Append.

HSS
CO 5%



135°