

€28,00

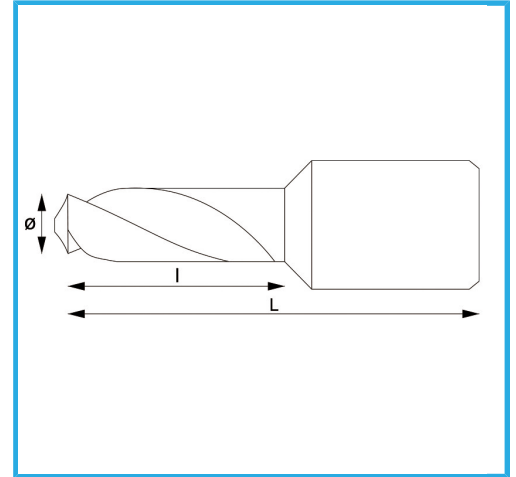

Ø	8 mm
l	30 mm
L	62.50 mm
Peso bruto	0,07 kg
Codigo de barras	8012667355654



Colgante

HSS
CO 5%



135°