

EL NÚCLEO DE DIAMANTE DE PARED DELGADA GARANTIZA CORTES SIN REBABAS. ESTA CARACTERÍSTICA FACILITA EL TRABAJO DE...

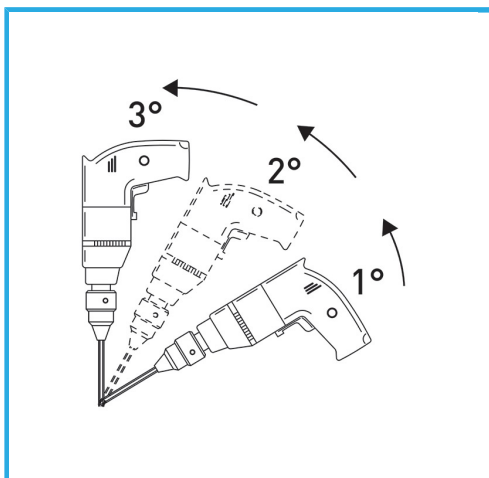

€17,90



Medida	Ø 7 mm
Conexión hexagonal	8.5 mm
Longitud total	56 mm
Altura del diamante	2 mm
Grano	50/60
Peso bruto	0,02 kg
Codigo de barras	8012667355104



Colgante