

WITH CAST ALUMINUM STRUCTURE, EQUIPPED WITH BATTERY,
CHARGER, INFRARED REMOTE CONTROL AND SOUND SIGNAL DOUBLE
UNIT OF...

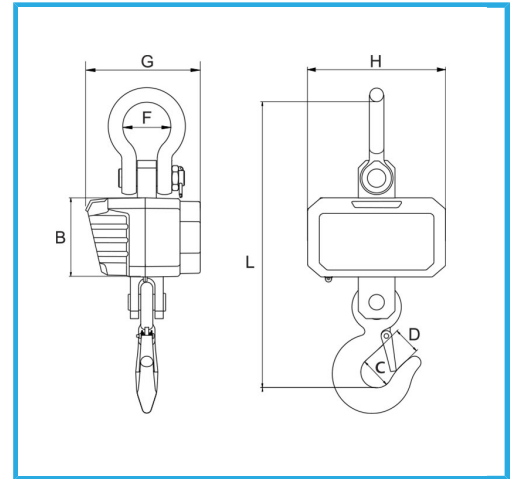

Digits sizes	40 x 20 mm
Capacity	3000 kg
Reading	1 kg
Minimum weighing	1 kg
Max weight	150%
Battery	1 x 6 V 4 Ah
Net weight	7,5 kg
EAN Code	8012667386115
Gross weight	8,67 kg



Box

Included

Battery charger
6V 4Ah battery
Infrared remote control
Upper shackle
Hook with anti-slip
device