

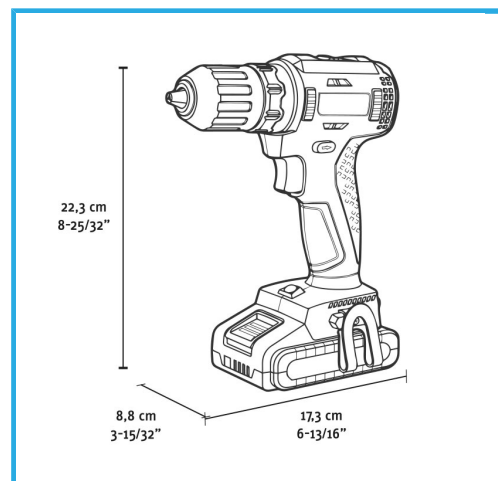







MOTOR BRUSHLESS, BLOQUEO AUTOMÁTICO DEL HUSILLO,  
PORTABROCAS AUTOAJUSTABLE SIN LLAVE, 21 CONFIGURACIONES  
DE EMBRAGUE,...



€274,00



|                                      |                            |
|--------------------------------------|----------------------------|
| <b>Velocidad de giro en vacío</b>    | 0-420 min-1 / 0-1400 min-1 |
| <b>Rango de apriete del mandril</b>  | 2 - 13 mm                  |
| <b>Par máx.</b>                      | 35 / 55 Nm                 |
| <b>Rendimiento de taladro acero</b>  | Max 13 mm                  |
| <b>Rendimiento de taladro madera</b> | Max 40 mm                  |
| <b>Diámetro máximo del tornillo</b>  | 8 mm                       |
| <b>Código de barras</b>              | 8012667407360              |
| <b>Dimensiones de embalaje</b>       | 365 x 320 x 100 h mm       |
| <b>Peso bruto</b>                    | 3,44 kg                    |

|   |   |
|---|---|
|  Estuche de transporte   |  Motor sin Escobillas    |
|  Velocidad Electrónica |  2 Funciones           |
|  Par Variable          |  Selector de Velocidad |
|  2 Funciones           | - 1 x 4Ah, 20V  |
|   | - 4A, 20V   |