

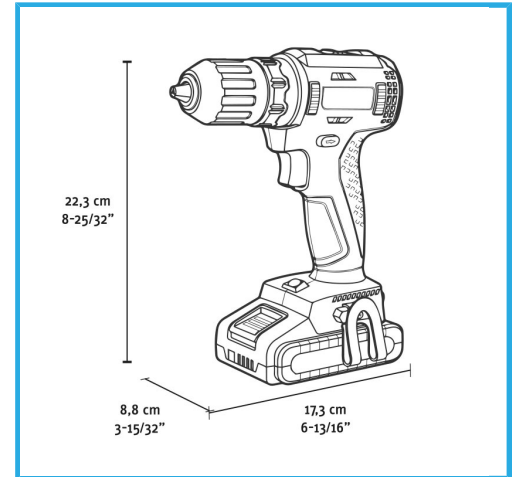







MOTOR BRUSHLESS, BLOQUEO AUTOMÁTICO DEL HUSILLO,
PORTABROCAS AUTOAJUSTABLE SIN LLAVE, 21 CONFIGURACIONES
DE EMBRAGUE,...



€366,00



Velocidad de giro en vacío	0-420 min-1 / 0-1400 min-1
Rango de apriete del mandril	2 - 13 mm
Par máx.	35 / 55 Nm
Rendimiento de taladro acero	Max 13 mm
Rendimiento de taladro madera	Max 40 mm
Diámetro máximo del tornillo	8 mm
Código de barras	8012667404291
Dimensiones de embalaje	365 x 320 x 100 h mm
Peso bruto	4,09 kg

 Estuche de transporte	 Motor sin Escobillas
 Velocidad Electrónica	 2 Funciones
 Par Variable	 Selector de Velocidad
 2 Funciones	- 2 x 4Ah, 20V
- 4A, 20V	