

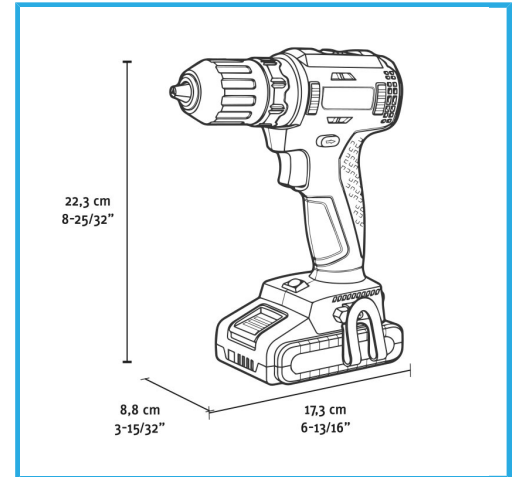







**ART. FB20CD3AB-22B**  
**CORDLESS DRILL - SCREWDRIVER 20V**



BRUSHLESS MOTOR, AUTOMATIC SPINDLE LOCK, KEYLESS  
SELF-TIGHTENING CHUCK, 21 CLUTCH SETTINGS, STEP SPEED  
SELECTION, ELECTRONIC...



<b>No-load speed</b>	0-420 min-1 / 0-1400 min-1
<b>Chuck tightening range</b>	2 - 13 mm
<b>Torque</b>	35 / 55 Nm
<b>Drilling output steel</b>	Max 13 mm
<b>Drilling output wood</b>	Max 40 mm
<b>Max screw diameter</b>	8 mm
<b>EAN Code</b>	8012667404284
<b>Gross weight</b>	3,38 kg

	Carrying case		Brushless Motor
	Electronic Speed		2 Functions
	Variable Torque		Speed Selector
	2 Functions	- 2 x 2Ah, 20V	
- 2A, 20V			