

ART. FB20ID3AB-22B

IMPACT DRILL / SCREWDRIVER 20 V

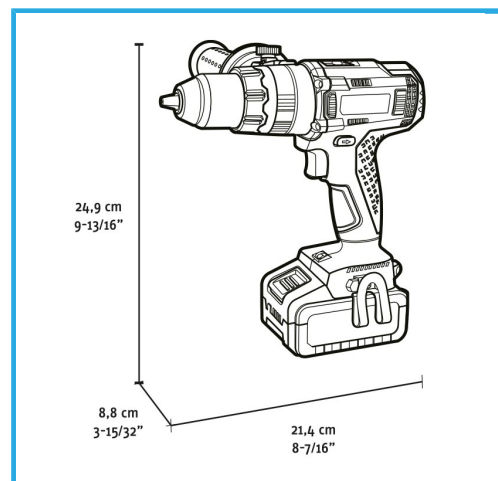

BRUSHLESS MOTOR, AUTOMATIC SPINDLE LOCK, METAL KEYLESS SELF-TIGHTENING CHUCK, 1 CLUTCH SETTINGS, STEP SPEED SELECTION, ELECTRONIC..



No-load speed	0-550 min-1 / 0-2000 min-1
Impact rate	0-7500 min-1 / 0-30000 min-1
Chuck tightening range	1,5 - 13 mm
Torque	70 / 75 Nm
Drilling output concrete	Max 16 mm
Drilling output steel	Max 13 mm
Drilling output wood	Max 40 mm
Max screw diameter	10 mm
EAN Code	8012667404314
Gross weight	4,38 kg

Carrying case	Brushless Motor
Keyless	Speed Selector
Electronic Speed	Variable Torque
3 Functions	- 2 x 2Ah, 20V
	- 2A, 20V