

ART. FB20CD3AB-12B
CORDLESS DRILL - SCREWDRIVER 20V

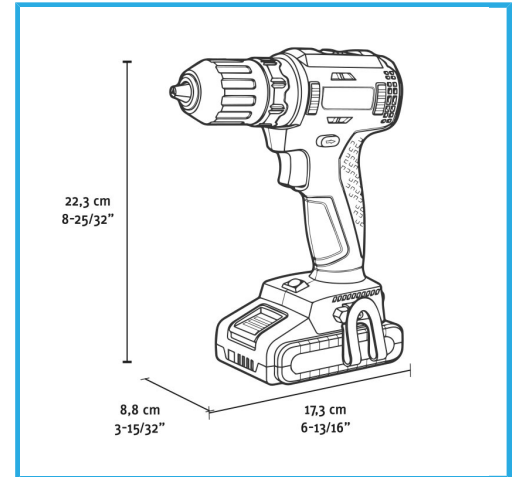

BRUSHLESS MOTOR, AUTOMATIC SPINDLE LOCK, KEYLESS
SELF-TIGHTENING CHUCK, 21 CLUTCH SETTINGS, STEP SPEED
SELECTION, ELECTRONIC...



No-load speed	0-420 min-1 / 0-1400 min-1
Chuck tightening range	2 - 13 mm
Torque	35 / 55 Nm
Drilling output steel	Max 13 mm
Drilling output wood	Max 40 mm
Max screw diameter	8 mm
EAN Code	8012667407353
Gross weight	3,00 kg

	Carrying case		Brushless Motor
	Electronic Speed		2 Functions
	Variable Torque		Speed Selector
	2 Functions	- 1 x 2Ah, 20V	
- 2A, 20V			