

FÜR DIE ZENTRIERUNG IN BESTEHENDEN BOHRUNGEN SORGT DIE FEDERBELASTETE, KONISCHE FRONT FÜR EINE GENAUE ZENTRIERUNG.

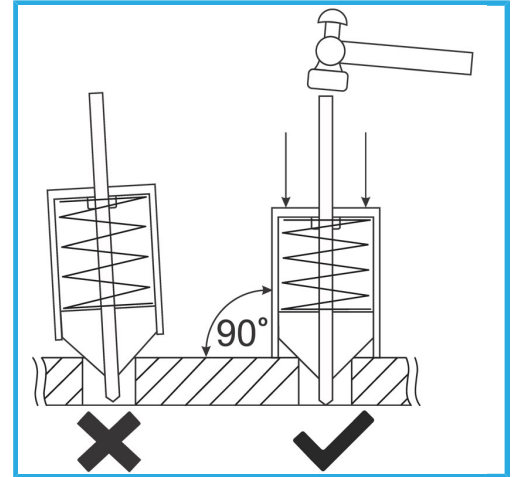

Länge	82 mm
Lochdurchmesser	Ø5 - Ø15 mm
Bruttogewicht	0,12 kg
EAN-Code	8012667408268



Box



Stahl