

PARA CENTRAR DENTRO DE ORIFICIOS EXISTENTES, LA PARTE FRONTAL CÓNICA ACCIONADA POR RESORTE PROPORCIONA UN CENTRADO PRECISO.

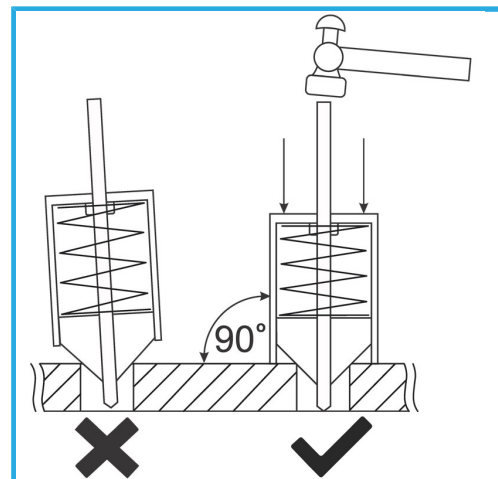

€8,00



Longitud	82 mm
Diámetro del agujero	Ø5 - Ø15 mm
Peso bruto	0,12 kg
Código de barras	8012667408268



Caja



Acero