

DIN 2080, CON CUERPO EQUILIBRADO, CON RANURA DE EXTRACCIÓN PARA HERRAMIENTAS. EQUILIBRADO 12.000 RPM.

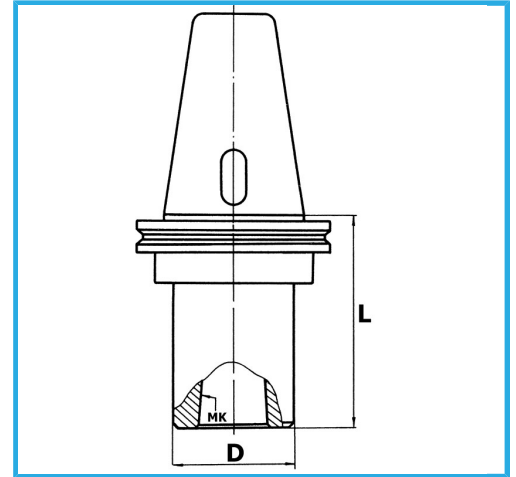

€100,00



ISO	40
CM	1
D	25 mm
L	50 mm
Peso bruto	0,97 kg
Codigo de barras	8012667407148



Caja



Rectificado