

DIN 2080, AUSGEWUCHTETES SPANNFUTTERGEHÄUSE, MIT
ABSAUGSCHLITZ FÜR WERKZEUGE. AUSWUCHTDREHZAHN 12.000
RPM.

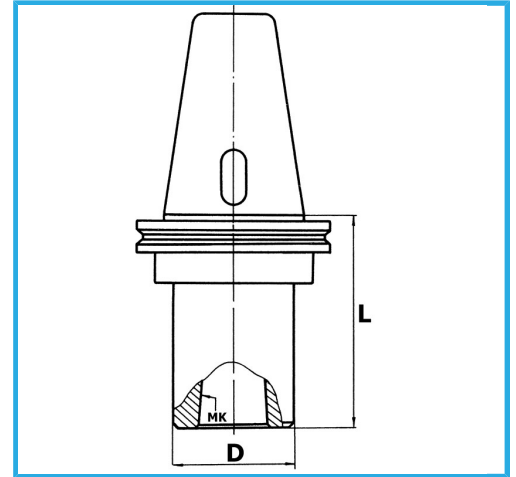

ISO	50
CM	1
D	25 mm
L	45 mm
Bruttogewicht	0,97 kg
EAN-Code	8012667407186



Box



Korrigiert