

DIN 2080, CON CUERPO EQUILIBRADO, CON RANURA DE EXTRACCIÓN PARA HERRAMIENTAS. EQUILIBRADO 12.000 RPM.

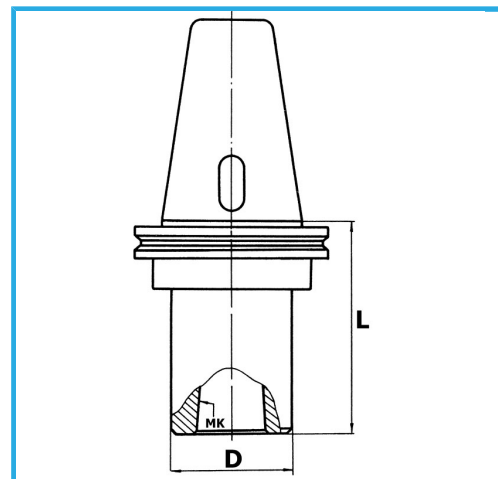

€161,00



ISO	50
CM	1
D	25 mm
L	45 mm
Peso bruto	0,97 kg
Codigo de barras	8012667407186



Caja



Rectificado